

MODEL 121A
ALIGNMENT SCOPE
INSTRUCTION MANUAL

78 10 7

783651

Power Requirements of this Product

Power requirements of this product have been changed and the relevant sections of the Operation Manual should be revised accordingly.

(Revision should be applied to items indicated by a check mark)

Input voltage

The input voltage of this product is _____ VAC,
and the voltage range is _____ to _____ VAC. Use the product within this range only.

Input fuse

The rating of this product's input fuse is _____ A, _____ VAC, and _____.

WARNING

- To avoid electrical shock, always disconnect the AC power cable or turn off the switch on the switchboard before attempting to check or replace the fuse.
- Use a fuse element having a shape, rating, and characteristics suitable for this product. The use of a fuse with a different rating or one that short circuits the fuse holder may result in fire, electric shock, or irreparable damage.

AC power cable

The product is provided with AC power cables described below. If the cable has no power plug, attach a power plug or crimp-style terminals to the cable in accordance with the wire colors specified in the drawing.

WARNING

- The attachment of a power plug or crimp-style terminals must be carried out by qualified personnel.

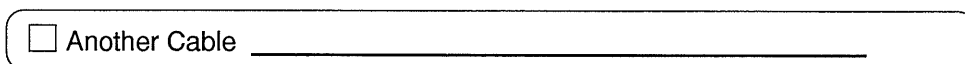
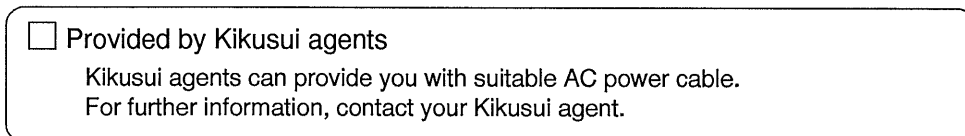
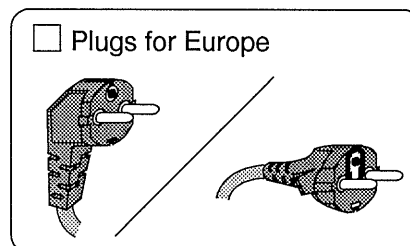
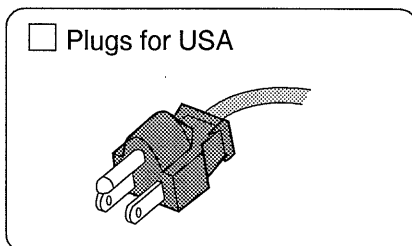
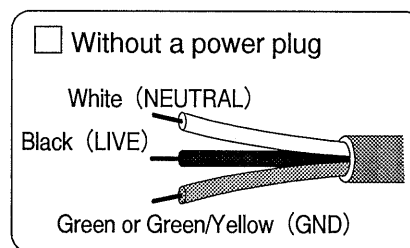
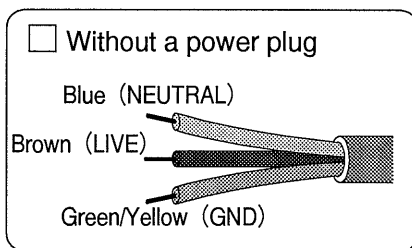

CONTENTS

	Page
1. General	1
2. Specifications	2
3. Operation	3
3.1 Explanation of panel	3
3.2 Explanation of rear	5
3.3 Caution on operation	6
3.4 Operation	7
4. Maintenance	8
4.1 Adjustment of incline of trace	8
4.2 Internal adjustments	8
4.3 Hood assembly	10
4.4 AC line voltage modification	11
4.5 Explanation of block diagram	12
5. Figures	
1. Front Panel and rear	14
2. Parts location	15
3. Block diagram	16

* Circuit diagram

723652

1. GENERAL

The MODEL 121A is an alignment scope using a 12 inches CRT for TV. The vertical system provides a frequency bandwidth of DC ~ 10 kHz and a sensitivity of 1 mV/DIV. Horizontal system provides a sensitivity of 100 mV/DIV or more and a frequency bandwidth of DC ~ 1 kHz, and has LINE SWEEP. Bright trace is disappeared at no signal input to the horizontal axis, and markers of two types (pulse marker and intensity-modulated marker) are available.

The MODEL 121A is usefull for adjustment of the production line of TV set, radio receiver and so on, as X-Y oscilloscope, for it has a broad screen, and very bright trace is obtained.

2. Specifications

Vertical axis	
Sensitivity	1mV/DIV, 10mV/DIV, 100mV/DIV, 1V/DIV in steps
Attenuation of sensitivity	Continuously variable up to 0 by VARIABLE
Frequency response	DC: DC ~ 10 kHz (-3dB, 1 kHz reference) AC: 3Hz ~ 10 kHz
Input resistance	Approximately 500 k Ω
POSITION	Selected by INT \leftrightarrow REMOTE
Horizontal axis	
Sensitivity	More than 100 mV/DIV
Attenuation of sensitivity	Continuously variable up to 0 by GAIN
Frequency response	DC ~ 1 kHz, (-3 dB 100Hz reference)
Input resistance	Approximately 500 k Ω
LINE SWEEP	Variable phase shift 130°
Pulse marker	
Sensitivity and pulse width	1 Vp-p/DIV, 20 μ sec. or more
Attenuation of sensitivity	Continuously variable up to 0
Input resistance	Approximately 100k Ω
Polarity of pulse	Positive and negative polarity selected
Intensity modulated marker	
Sensitivity and pulse width	1 Vp-p, 10 μ sec. or more
Polarity	Brightness is increased by positive and negative signal.
Scale	10DIV x 14DIV (1 DIV = 14mm)
Distortion or linearity	Within $\pm 5\%$ of full scale (vertical and horizontal)
Orthogonality	Within 90° $\pm 2^\circ$ at the center of the graticule area
Insulation	DC 500V line and chassis more than 30M Ω
Dimensions (max.)	430(435) W x 250(265)H x 350(390)D mm
Weight	Approximately 13.5 kg
Power consumption	115V 50Hz approximately 50 VA
Accessories	Instruction manual 1 942A Terminal adaptor 2

3. OPERATION

3.1 Explanation of Panel

POWER	When this switch is turned upward, power is turned on, lamp lights.
INTENSITY	Knob for adjustment of brightness of display. Brightness increases with clockwise rotation. The INTENSITY control circuit operates, when input signal is applied to the horizontal amplifier, and trace is appeared. When no input signal is applied to the H.INPUT, the INTENSITY can be adjusted by setting the LINE /EXT knob to the LINE SWEEP.
VERTICAL	
INPUT	Vertical input connector. Signal is fed to the vertical amplifier through the AC/DC selector and the VOLTS/DIV selector. Allowable maximum input voltage is 100 V.
AC/DC	Selector of method of the coupling input signal to the vertical amplifier. In AC position, DC component of input signal is blocked by a capacitor, and only the AC component can be measured. In DC position, input signal is directly applied to the vertical amplifier through attenuator, and all components of the input signal can be observed.
VOLTS/DIV	Sensitivity selector. 1 mV/DIV, 10 mV/DIV, 100 mV/DIV and 1 V/DIV are selected in steps. 1 mV/DIV and 10 mV/DIV are selected in the vertical amplifier, and 100 mV/DIV and 1 V/DIV are selected by attenuators.
VARIABLE	Control for sensitivity of vertical axis. Sensitivity is continuously variable, and it increases with clockwise rotation. Sensitivity is calibrated in the fully clockwise position, and it is attenuated to zero in the fully counterclockwise position (CAL position).

- ↑ POSITION Knob for control of vertical position of trace. It shifts upward with clockwise rotation, and downward with counterclockwise rotation.
- ⊗ DC BAL A semi-fixed resistor for DC balance of vertical amplifier. It must be adjusted so as not to shift a trace, when VOLTS/DIV is turned to 1 mV/DIV from 10 mV/DIV.
- HORIZONTAL
- LINE/EXT Internal LINE SWEEP or external sweep signal is selected by this knob as a horizontal input signal.
- LINE : A sine-wave signal from line supply is applied to the horizontal amplifier, after its phase is controlled.
- EXT : A sweep signal from external signal generator must be applied to the H INPUT terminals on rear panel.
- PHASE In the LINE SWEEP position described above, phase can be controlled by this knob.
- ↔ POSITION Knob for control of horizontal position of trace. It shifts rightward with clockwise rotation and leftward with counterclockwise rotation.
- FOCUS Knob for a sharp and well-defined trace or spot.

3.2 Explanation of Rear Panel

- REMOTE/INT The vertical position of trace can be controlled by the VERT POSITION knob from the front panel and external signal from the REMOTE connector. Select the method desired by this selector.
- REMOTE It is possible to adjust vertical position from outside by connecting an external variable resistor with 50 k Ω B with the REMOTE connector. See CIRCUIT DIAGRAM for how to connect the connector pins.
- H INPUT Horizontal input terminal. It is a BNC connector, and sweep signal is applied to it from sweep generator.
- GND Ground terminal.
- PULSE / INTEN
MARKER / MODU Marker selector for selecting pulse marker or intensity-modulated marker.

PULSE MARKER

- POLARITY Selector for selecting pulse marker polarity. Marker polarity on the CRT screen can be inverted.
- AMPLITUDE Knob for adjusting amplitude of pulse marker. Amplitude of pulse marker input signal is continuously variable.
- MARKER INPUT Input terminal for pulse marker.

INTEN MODU

- BRIGHTNESS Brightness of intensity-modulated marker is continuously variable.
- MARKER INPUT Input terminal for intensity-modulated marker.

783657

3.3 Caution on Operation

1. When the horizontal trace on the CRT screen is not parallel to the horizontal graticule line, adjust it by turning the deflection yoke, after loosening a screw. (See 5.2 Parts Location)
2. To protect the CRT screen from phosphor burns, spot blanking circuit (spot killer) operates, when no input signal is fed to the horizontal amplifier. In this case, brightness of spot is decreased, and spot is disappeared. But, if the INTENSITY knob is set near maximum clockwise position, bright spot may be appeared. If the condition described above is kept for a long time, the CRT phosphor may be burned. If the input signal being fed to the horizontal amplifier is suddenly cut off, when the INTENSITY knob is in about maximum position, the horizontal amplitude becomes minimum. As there exists a certain period of time until the disappearance, the CRT phosphor is burned. In such operation as described above, therefore, it is desirable to keep the INTENSITY knob in the minimum position.
3. When the VARIABLE knob is set in the maximum clockwise position, sensitivity of vertical amplifier is calibrated.
4. Allowable vertical input voltage is 100 V (DC+ACpeak).
5. When the AC line voltage is changed to 115V or 230V, refer to Item 4.4 of Section 4 "Maintenance".

3.4 Operation

1. Turn the POWER switch to ON.
2. Set the LINE/EXT switch to LINE, and turn clockwise the HOR GAIN knob. Turn clockwise the INTENSITY knob. A horizontal trace will be appeared.
3. Adjust the INTENSITY knob and the FOCUS knob for optimum display definition.
4. Turn the REMOTE/INT switch on the rear to the INT, and adjust the VERTICAL POSITION knob for optimum display position of a trace.
5. Connect a input signal to the VERTICAL INPUT terminal, and turn clockwise the VARIABLE knob. A trace is appeared.
6. Adjust the phase of the LINE sweep by the PHASE knob.
7. When marker signal is utilized, connect a marker signal to the MARKER INPUT on the rear, and select the PULSE MARKER or the INTEN MODU. Adjust the AMPLITUDE knob or the BRIGHTNESS knob for the optimum display definition, after the marker signal is appeared.
8. When external sweep is used, a sweep signal must be applied to the H INPUT on the rear. Turn the LINE/EXT selector on the front panel in the external position, and adjust the HOR GAIN knob for the desired sweep width on the CRT screen.

4. Maintenance

4.1 Adjustment of Trace Alignment

Set the LINE/EXT selector to the LINE position, and apply no input signal to the vertical input position a trace to the horizontal center.

If the trace is not parallel to the horizontal graducule line, adjust the CRT as follows.

- (1) Remove the top plate from housing.
- (2) After loosening the clamp screw of the deflection yoke at the neck portion of the CRT, Turn it so that the trace is parallel to the horizontal graticule line.
- (3) Carefully push the yoke toward the front of the CRT. Fix the yoke, after closely attaching it by the clamp screw.

Warning

- a) Do not move the centering magnet and the magnet or compensation of the yoke.
- b) Be careful, for high accelerating voltage is provided to the CRT.
- c) Be carefully so as not to give it any strong shock for impulse, for the neck portion of the CRT is mechanically weak .

4.2 Adjustment of internal parts (Refer to 5-2 parts location)

Adjust in order of following procedure, when any of parts is replaced or any of characteristics does not meet specified requirement. Some adjustments marked * must be adjusted , only when relative parts are replaced.

- (1) Check of supply voltages
Check that the voltage of Pin 4 of the voltage regulator IC (TA7179P) on the printed circuit board is $+15V \pm 0.5V$ and that of Pin 11 is $-15V \pm 0.5V$.
- (2) INTEN ADJ
Adjust it so that trace is dimly appeared in the position of approximately $1/3$ turns of INTENSITY knob on the front panel from the maximum counterclockwise position.

(3) H.BIAS ADJ

Adjustment for control of current in final transistor of horizontal amplifier or compensation of horizontal linearity, and position the spot to horizontal graticule center, and measure the voltage across the resistor (10Ω) in series to emitter.

Adjust the H.BIAS ADJ for 2.0 V ~ 2.2 V (approximately 200mA of emitter current). Make the horizontal trace 3 DIV at the graticule center.

Confirm the amplitude of the horizontal trace is not largely changed at the right end or the left end. When moving it right and left.

(4) LINEARITY ADJ

Adjustment for compensation of linearity of horizontal deflection. Adjust the linearity of the horizontal trace on the CRT screen.

(5) V.BIAS ADJ

Adjustment for control of current on final transistor of the vertical amplifier or compensation of vertical linearity. Set the VOLT/DIV to the 10 mV/DIV, and position spot to the vertical graticule center. Measure the voltage across the resistor (2.2Ω) in series to emitter, and adjust the V.BIAS ADJ for 0.66 V ~ 0.7 V (approximately 300mA of emitter current).

Make the vertical trace a few DIV at the graticule center. Confirm that the amplitude of the vertical trace is not largely changed at the upper end or the lower end, when moving it upper and lower.

(6) DC BAL ADJ

Set the DC BAL knob of the front panel in a mid-position of its adjusting range, and so adjust the semi-fixed resistor (R107) that the trace base line does not shift when the sensitivity is switched between 10mV/DIV and 1mV/DIV ranges.

(7) VERT GAIN ADJ

For adjustment of 10mV/DIV range, set the VARIABLE knob in the CAL position and adjust the GAIN control (R120). For adjustment of the 1mV/DIV range, set the VARIABLE knob in the CAL position and adjust the GAIN control (R121).

When adjusting both 10mV/DIV and 1mV/DIV ranges, be sure to adjust the 10mV/DIV range at first.

783661

4.3 Hood assembly

The hood which is OPTION of the MODEL 121A is used to shield the CRT screen against light incident from above.

Refer to the bellow illustration to assemble the hood.

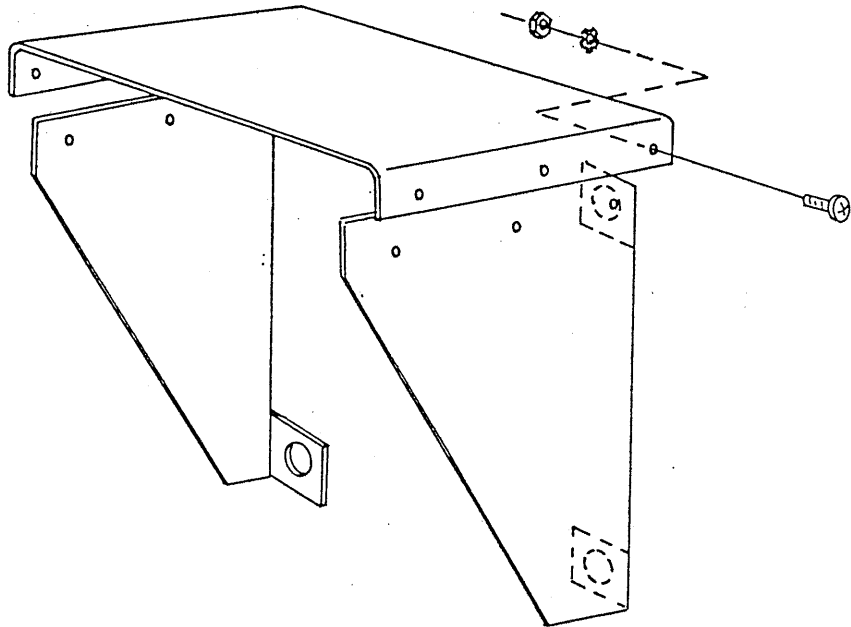

Fig. 1 Hood assembly

783662

4.4 AC line voltage modification

This instrument is shipped from the manufacturer's factory being set for use on an AC line of 115V $\pm 10\%$ (230V $\pm 10\%$).

The setting can be changed for use on a 230V $\pm 10\%$ (115V $\pm 10\%$) line voltage.

- (1) Remove the name plate (LINE VOLTS 115V or LINE VOLTS 230V). To use on a 115V line, slide the switch to the left and so mount the name plate that the "115V" mark is visible.

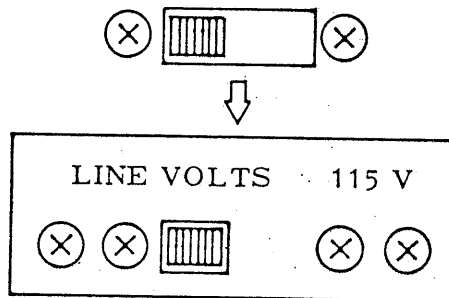

- (2) To use on a 230V line, slide the switch to the right and so mount the name plate that the "230V" mark is visible.

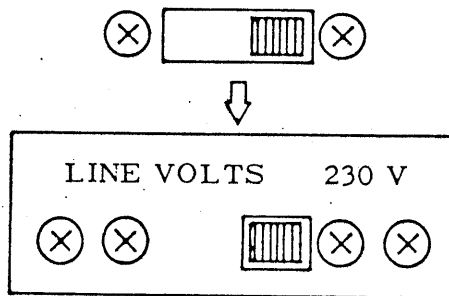

- (3) FUSE

115V	1A SLOW BLOW
230V	0.5A SLOW BLOW

4.5 Explanation of Block Diagram

(Refer to Block Diagram and Circuit Diagram)

1. Vertical axis

Vertical input signal is connected to differential amplifier via the AC/DC selector, the VOLTS/DIV selector (1mV/DIV, 10mV/DIV, 100mV/DIV, 1 V/DIV), and the VARIABLE knob (variable up to 0 from CAL position) Amplifier gain can be calibrated at the 1 mV/DIV and the 10mV/DIV, and the current at the final stage of approximately 300mA is controlled.

2. Horizontal axis

The EXT sweep and the LINE sweep are available by a selector for the horizontal axis, the line sweep is operated by the internal waveform.

The PHASE knob on the front panel must be adjusted so that the phase of the internal line sweep coincides with the phase of a signal measured. Input signal is connected to a differential amplifier via the GAIN control. (It can be attenuated up to 0.)

The amplifier has a constant gain, and controls approximately 200 mA at final stage.

Linearity of horizontal deflection can be compensated by a varistor and a variable resistor.

3. Blanking Spot circuit

Blanking spot circuit detects a horizontal signal, and controls a beam of electron by first grid of the CRT.

The trace is bright, when input signal is applied to the horizontal axis, and the trace is disappeared at no signal input. However, when the INTENSITY knob is adjusted near the maximum clockwise position, a spot may be appeared, although brightness decreases with operation of the circuit.

Refer to ' Caution on operation ' to protect the phosphor of the CRT screen from burning of it.

4. A pulse marker is applied to the vertical amplifier via an attenuator for marker. Polarity of the marker on the CRT screen is changed by using the pulse marker polarity selector.

5. Intensity-modulated marker

The intensity-modulated marker signal is amplified by the amplifier via an attenuator, and it controls the cathode voltage of the CRT. Brightness automatically increases, when the marker signal is applied even if it is not only positive polarity but also negative polarity.

6. High-voltage circuit

The high voltage generator in the high voltage unit oscillates at a frequency of approximately 45 kHz. The oscillated power is boosted with a transformer and rectified into a DC acceleration voltage of approximately 6.3 kV for the CRT.

Front panel and rear

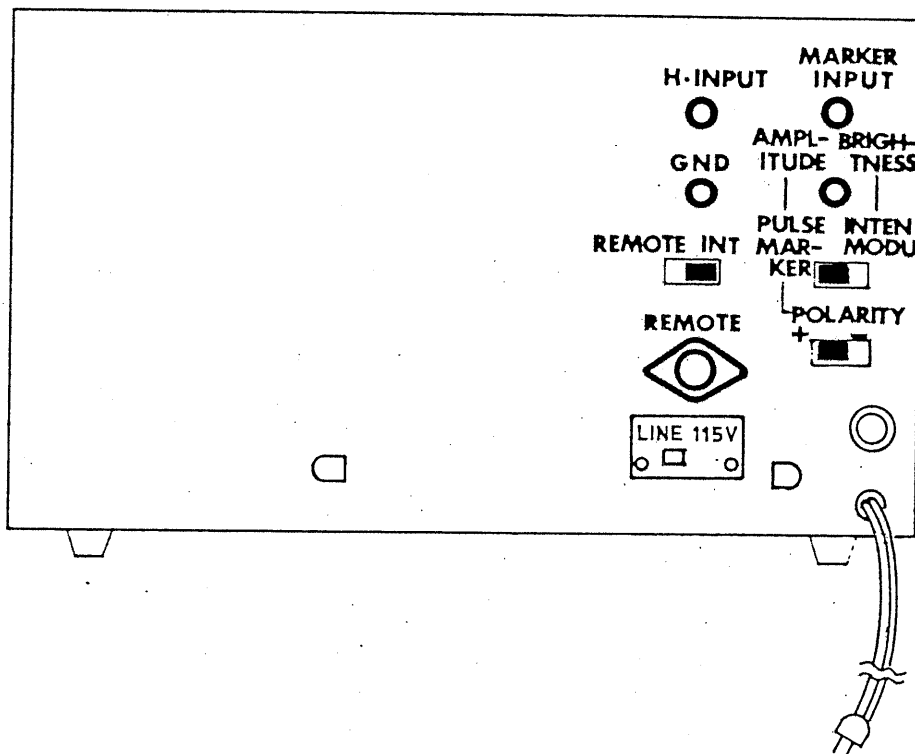
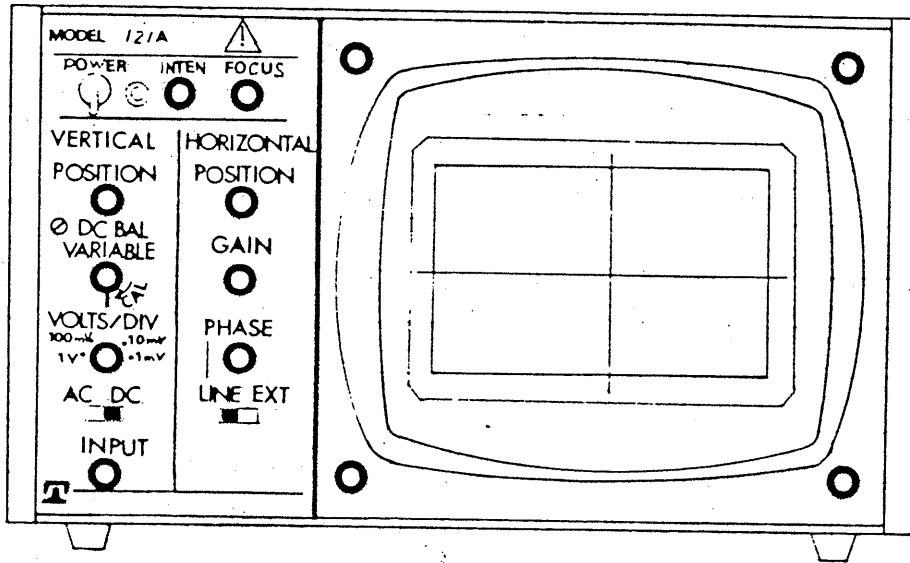

783666

Parts location

TOP VIEW

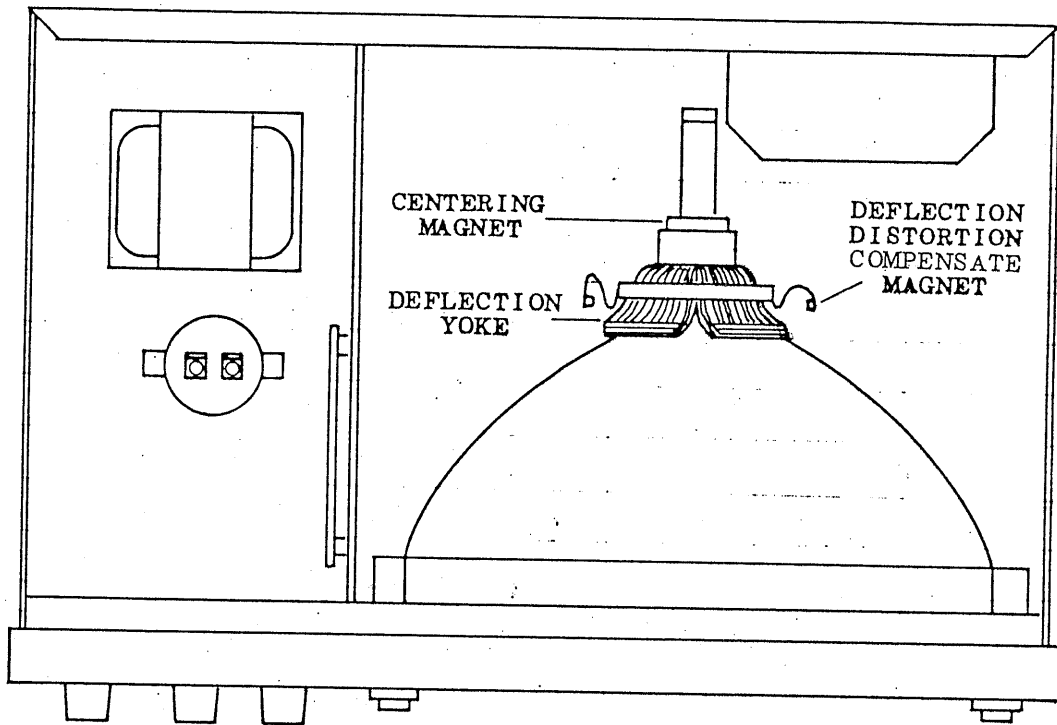

LEFT SIDE VIEW

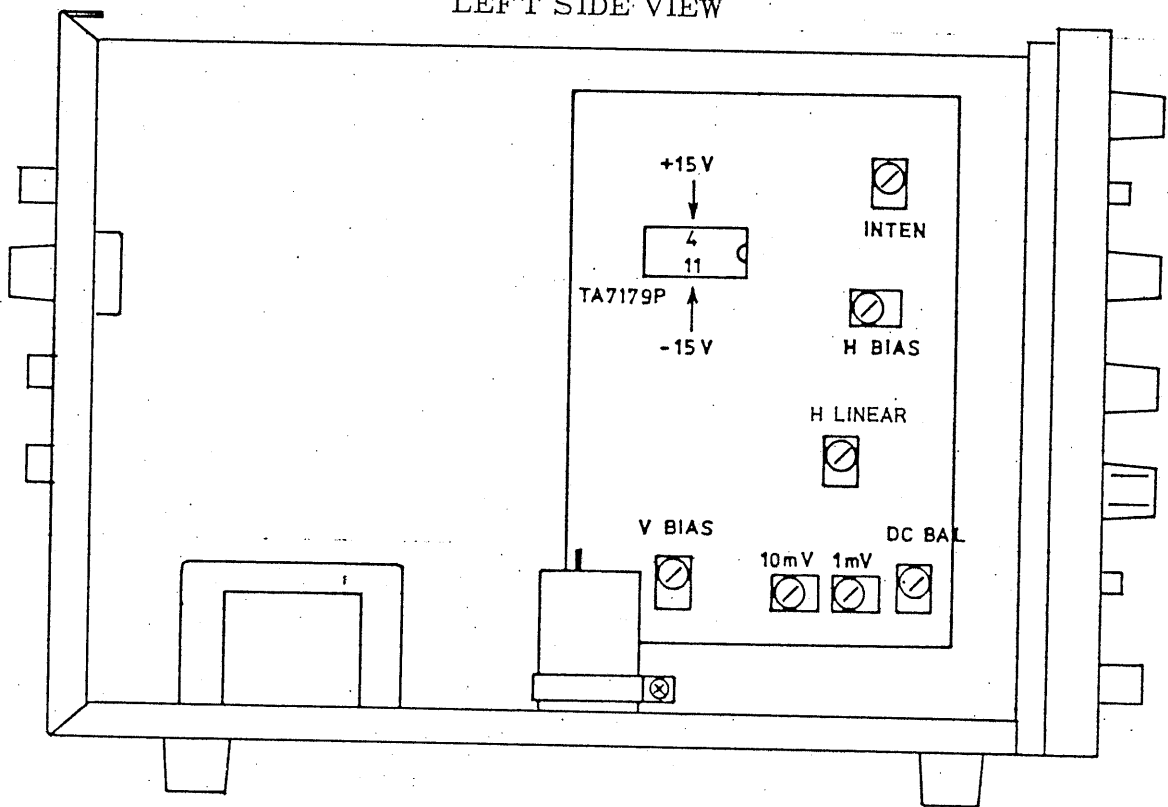

783667

7836687

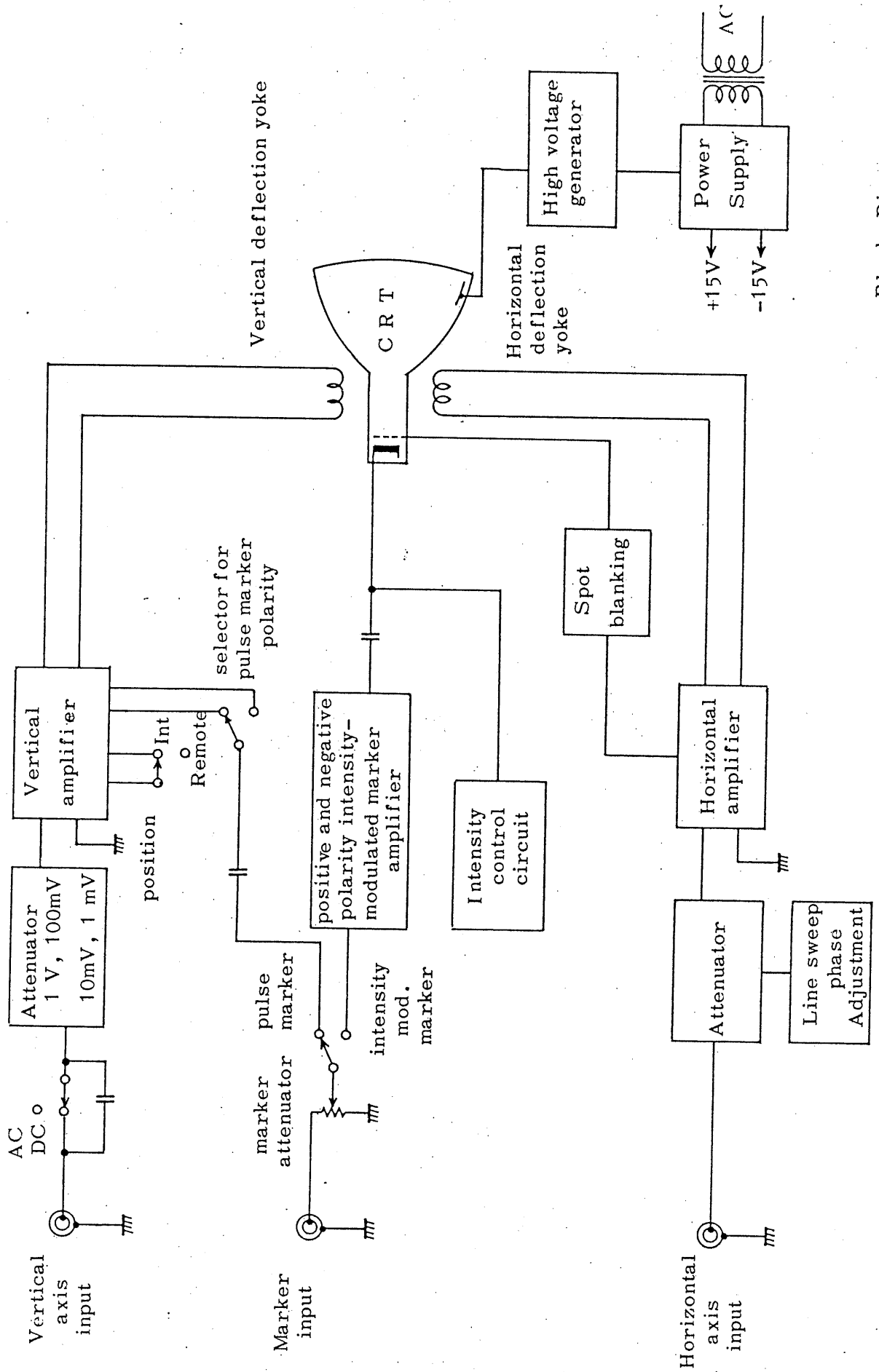

Block Diagram